

0 603 245 503; 538

Issue } 06-10-25 **Fig./Abb. 2**
Stand }

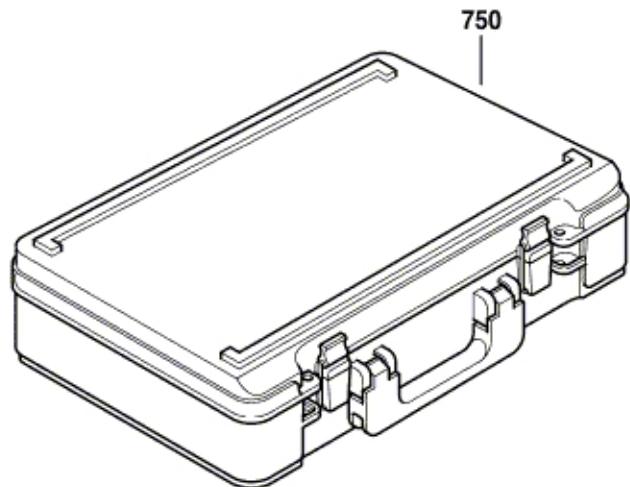
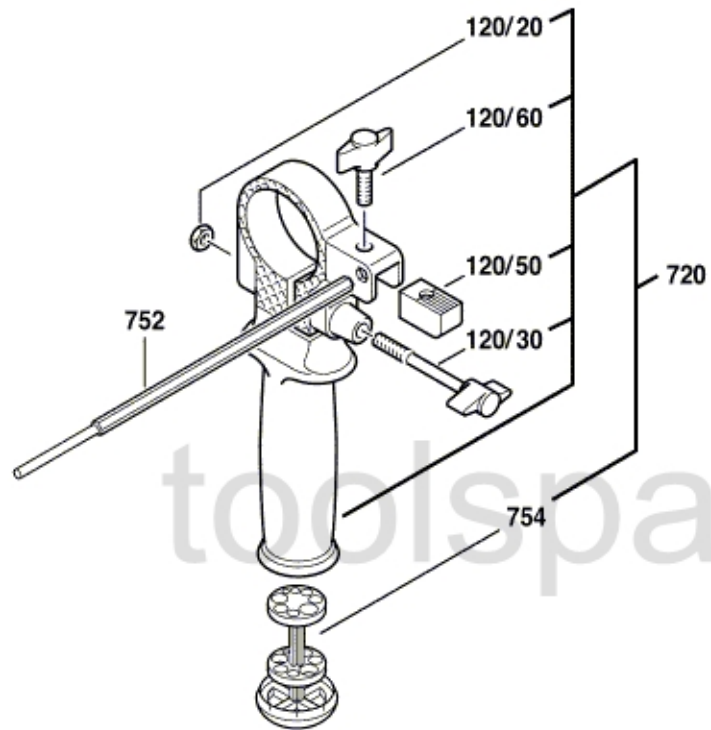

Modifications reserved
Änderungen vorbehalten
Modifications réservées
Salvo modificaciones